



**MARSDEN**  
ACCURACY ASSURED

OPERATIONS MANUAL

# MBF-6000 & MBF-6010

Please take the time to read these  
instructions before starting  
to use the scales



# Table of Contents

TABLE OF CONTENTS .....	2
PREFACE .....	3
GENERAL INFORMATION.....	3
NOTES ON SAFETY.....	3
ENVIROMENTAL.....	3
MAINTENANCE.....	4
WARRANTY-LIABILITY .....	4
DISPOSING OF THE SCALE.....	4
SPECIFICATION .....	7
SPECIFICATION .....	8
PRODUCT STRUCTURE .....	9
PRODUCT STRUCTURE .....	10
PANEL AND KEY FUNCTION.....	11
PANEL AND KEY FUNCTION.....	12
DISPLAY.....	13
BEFORE OPERATION.....	14
<i>SETTING TIME AND DATE</i> .....	15
<i>OPERATION INSTUCTION Body Composition Analysis</i> .....	16
<i>OPERATION INSTUCTION Body Composition Analysis</i> .....	17
SET UP YOUR DEVICE.....	19
RS-232 INTERFACE INSTRUCTIONS.....	20
FORMAT OF THE PRINT OUT.....	21
ASSEMBLY INSTRUCTION .....	22
INSTRUCTION FOR REPLACING BATTERIES.....	24
MBF-6010 ASSEMBLY .....	25
ERROR MESSAGE.....	26

## Preface

Thank you for choosing our product. All features of this product were designed to state of the art and are optimized for simple and straightforward use. If you have any queries or experience any problem not addressed in the operating instructions please contact our sales/service staff.

## General Information

We strongly recommend you use this device on a flat and hard surface. Any soft surface, like carpet will cause inaccuracy. We strongly recommend you use this device on flat and hard surface. Any soft surface, like carpet will Cause inaccuracy.

## Notes on Safety

### **Danger:**

Never use this unit in combination with medical electronic devices such as:

- Medical electronic implants such as pacemakers
- Electronic life support systems such as an artificial heart/lung
- Portable electronic medical devices such as an electrocardiograph.

This unit may cause the above mentioned medical electronic devices to malfunction.

### **Caution:**

Before putting the device into use, please read with care the information given in the operating instructions. They contain important instructions, proper use and maintenance of the device.

The manufacturer shall not be liable for damages arising out of failure to heed the following instructions:

- When using electronic components under increased safety requirements, always comply with the appropriate regulations.
- Improper installation will render the warranty null and void.
- Ensure the voltage marked on the power supply unit matched your main power supply.
- This device is designed for the indoors.
- Observe the permissible ambient temperatures for use.
- The device meets the requirements for electromagnetic compatibility. Do not exceed the maximum values specified in the applicable standards.

If you have any problem please contact our sales/service people.

Before putting the device into use, please read with care the information given in the Operating Instructions. They contain important instructions for installation, proper use and maintenance of the device.

The manufacturer shall not be liable for damages arising out of failure to heed the following instructions:

When using electrical components under increased safety requirements, always comply with the appropriate regulations.

Improper installation will render the warranty null and void.

Ensure the voltage marked on the power supply unit matches your main power supply.

This device is designed for use indoors.

Observe the permissible ambient temperatures for use

The device meets the requirements for electromagnetic compatibility. Do not exceed the maximum values specified in the applicable standards.

If you have any problem, please contact our sales / service people.

## Environmental

- All batteries contain toxic compounds; disposal of batteries should be delegated to a competent organization, complying with the deposit of Poisonous Waste Regulation 1972.

- Please do not incinerate batteries.
- The optimum operating temperature for the scale is 5°C to 35°C, although it will operate at higher and lower temperatures the scale battery life will adversely be affected.

## Maintenance

The scale does not require any routine maintenance. However, we recommend checking the scales accuracy at regular intervals. The regularity of these checks is independent on the level of use and the state of the scale. If any inaccuracies occur, please contact our sales/service people.

## Weighing Operation

Before reading detailed instructions on how to use all the weighing functions that are built into your scale, please read the following important guidelines.

- Always be sure that the display shows '0.0' before use, if it does not then please press the ZERO key.
- The device is designed to detect when a stable weight is achieved, the indicator will 'bleep' twice to indicate a stable weight value, your reading should be taken at this point.

## Warranty-Liability

- If a fault or defect is present on receipt of the unit which is within our scope of responsibility, we shall have the right to either repair the fault or supply a replacement unit. Replaced parts shall be the property of CHARDER. Should the fault repairs or replacement delivery not be successful, the statutory provisions shall be valid. The period of warranty shall be two years, beginning on the date of purchase. Please retain your receipt as proof of purchase. Should your scale require servicing, please contact.
- No responsibility shall be accepted for damage caused through any of the following reasons: Unsuitable or improper storage or use, incorrect installation or commissioning by the owner or third parties, natural wear, changes or modifications, incorrect or negligent handling, overuse, chemical, electrochemical or electrical interface or humanity, unless this is attribute to negligence on the part of the manufacturer.
- If operating, climatic or any other influences lead to a major cause in conditions or material quality, the treaty for perfect unit functioning shall be rendered null and void. If we provide an individual warranty, this means that the unit supplied will be free of faults for the length of the warranty period.

## Disposing of the Scale

- This product is not to be treated as regular household waste, but should be handed into an electrical/electronic equipment recycling centre.
- You can obtain further details from your local council, your municipal waste disposal company or the firm which you purchased the product.



- **Individuals with a pacemaker or other internal medical devices**  
This equipment sends a weak electrical current through the body during measurements. Individuals who have internally implanted medical devices, such as pacemakers, should not use this medical equipment due to the risk of malfunction to the device that may be caused by the weak electrical current.
- **Inserting and removing power cord**  
To reduce the risk of electrical shock or product damage, never insert or remove the power cord with wet hands.
- **Do not under any circumstances dismantle or alter the device, as this could result in electric shock or injury as well as adversely affect the precision of the measurements.**
- **To prevent fire hazard**
- **Use only a correctly wired (100-240VAC) outlet, and do not use a multiple outlet extension cable.**
- **Measurements for physically disabled people**  
Physically disabled persons should not attempt to take measurements alone, but instead should have their caretakers assist them in using the device.
- **Keep the unit out of reach of young children.**



- **Cross contamination**  
The body composition analyser should be used with bare feet. Please be sure to clean the scale platform with appropriate disinfectant after each use. Never pour liquid directly on the scale platform, as it may leak and cause internal damage. Use a soft cloth and appropriate ethyl alcohol wipe off the platform. Do not wipe the platform with strong chemicals.
- **Clean**  
We would recommend using alcohol based wipes or similar when cleaning the scale  
Please do not use large amounts of water when cleaning the scales as this will cause damage to the scales electronics, you should also refrain from using corrosive liquids or high pressure washers.  
Always disconnect the scales from the mains power supply before cleaning.
- **Interpretation of Results**  
The data provided by this machine, as well as any supplementary information such as diet or exercise programs based on this data, should be interpreted by a licensed professional.
- **Please make sure you place the weighing platform on a level and stable surface. If the equipment is used when the weighing platform is unstable because not all the feet are on the surface there may be risk of stumbling and malfunctioning or inaccurate measurement.**
- **For the MBF-6000/MBF-6010; ensure you use the original AC adaptor. Using an AC adaptor other than the original may cause malfunction.**  
Do not insert or remove the plug by the cable.



## **Maintenance**

Since the equipment is accurately manufactured and adjusted, please observe the following instructions.

- Never disassemble the equipment as this may cause malfunction. Users must not disassemble or adjust the equipment.
- Unplug the unit from the wall outlet when it will not be in use for long periods of time.
- Keep the electrodes clean by wiping them with disinfectant.
- Do not drop the unit, and avoid locations with constant vibration.

Do not drop this equipment in direct sunlight, close to heaters or near direct draughts from air conditioners.

## Specification

Model		MBF-6000	MBF-6010
Weight Measurement	Capacity	300kg x 0.1kg	
	Weight Unit	Kg (approved)	
	LCD Display	0.8 inch LDC display (Three Row LCD)	
	Key Functions	On/Off, Zero, Pre-Tare, Body Type 0~9, Clear, Enter, Time, Print	
	Accuracy	0.15kg	
Impedance Measurement	Measurement System	4 Polar bioelectrical Impedance Analysis	
	Measurement Current	50kHz 500uA	
	Measurement Style	Right leg, Left leg	
	Measurement Range	200 ~ 1000Ω / 0.1Ω	
Input Items	Gender	Male / Female	
	Body Type	Standard / Athletic	
	Age	10 – 80 years old	
	Height	60 – 210cm / 2ft – 7ft 11.0in	

## Specification

Output items (Display and print out)	Date	DD/MM/YYYY hh:mm EX: 30/10/2008 10:55
	Body Type	Standard / Athletic
	Gender	Male / Female
	Age	10 – 80 years old / 1 year increments
	Height	60 – 210cm / 2ft – 7ft 11.0in
	Weight	0-300kg
	BMI	0.1 increments
	BMR	1 kcal increments
	Fat%	5-50% / 0.1% increments
	Fat Mass	0.1kg increments
	FFM	0.1kg increments
	TWB	0.1kg increments
Platform Dimensions		450 (L) x 340 (W) x 88 (H) mm
Power Supply		7.2V 2000mA rechargeable battery or AA (1.5X6) 9V batteries. Medical switch AC adaptor 12V 2A
Operation Temperature & Humidity		5°C - 35°C 35% / 90% RH
Storage Temperature and Humidity		-20°C - 60°C 25% / 95% RH
OPTION		THERMAL PRINT / Height meter
RS232		9D CONNECT (FEMAL) FOR PC



# Product Structure

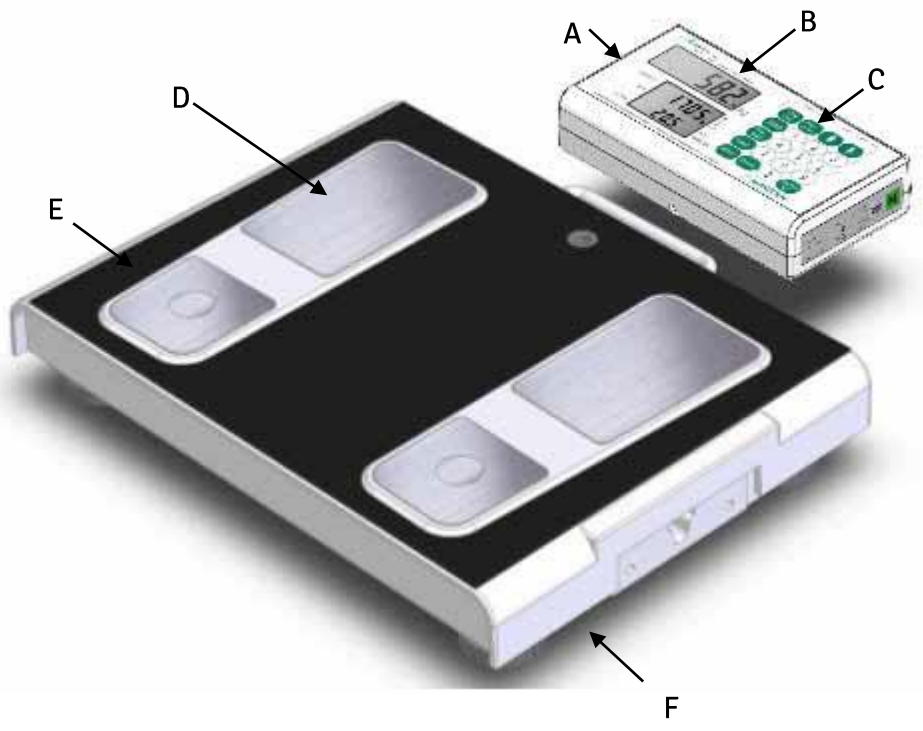

- A: Remote Display
- B: Digital LCD
- C: Control Panel
- D: Posterior Electrodes
- E: Platform
- F: Adjustable feet
- G: Battery Type

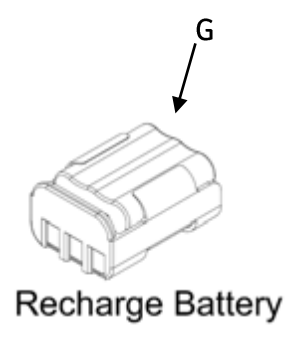

# Product Structure

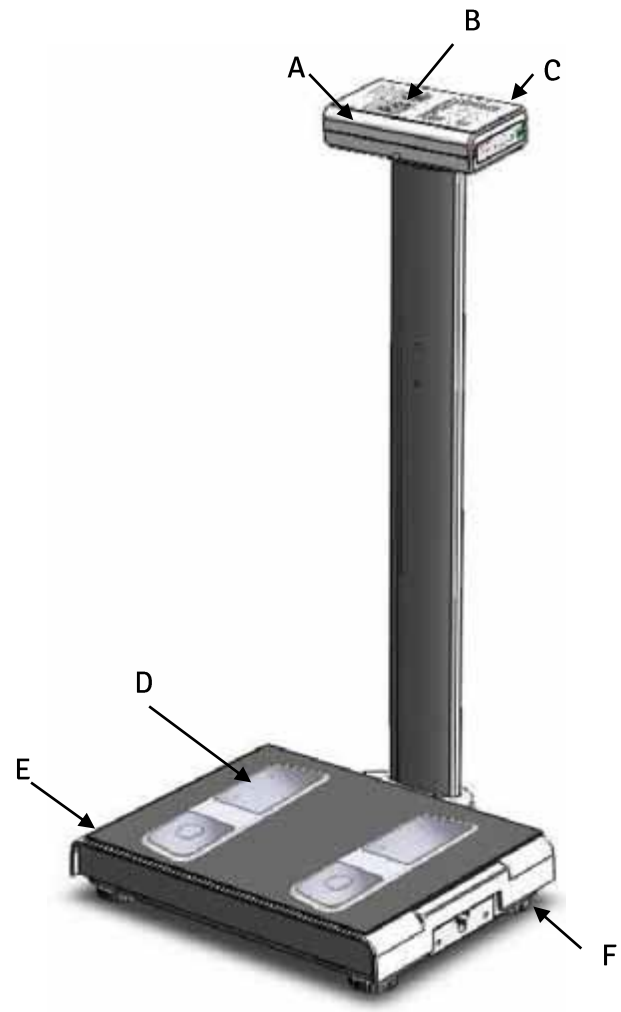

- A: Remote Display
- B: Digital LCD
- C: Control Panel
- D: Posterior Electrodes
- E: Platform
- F: Adjustable feet
- G: Battery Type

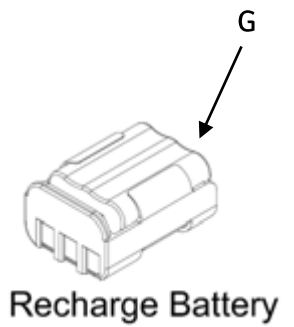

## Panel and Key Function

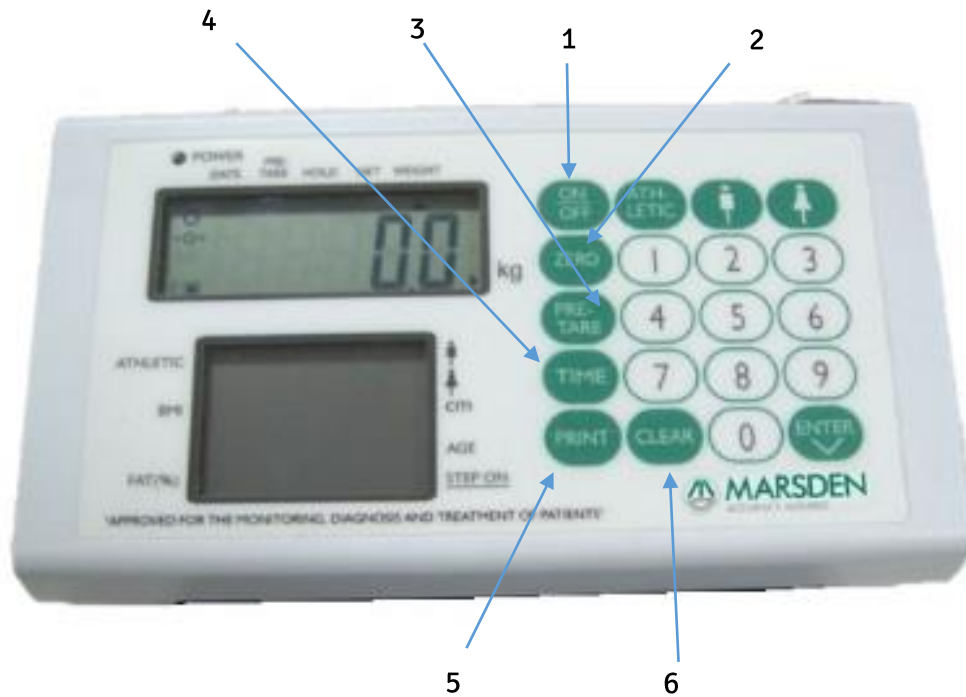

1: On/Off – Power On or Power Off

2: Zero – Zero the system

3: Pre-Tare – Deduct the weight of clothing before measuring

4: Time – Set the time and date

5: Clear – Press this key to return to normal mode

6: Print – When printer or PC is connected to the scale, press this key to print patients weight, height, body type, age, fat, BMI. Fat mass, BMR, TBW and FFM.

## Panel and Key Function



- 1: Enter – In setting function mode, this key means “enter”. In normal mode, this key means “down”
- 2: Standard Male
- 3: Standard Female
- 4: Athletic

# Display

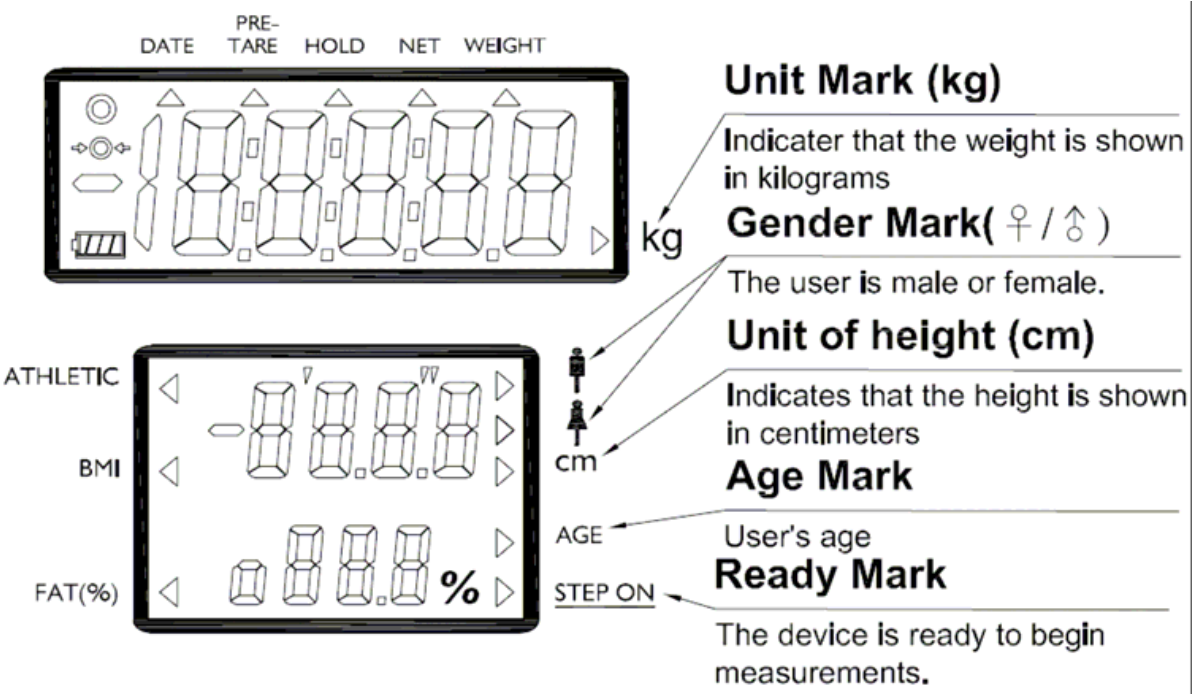
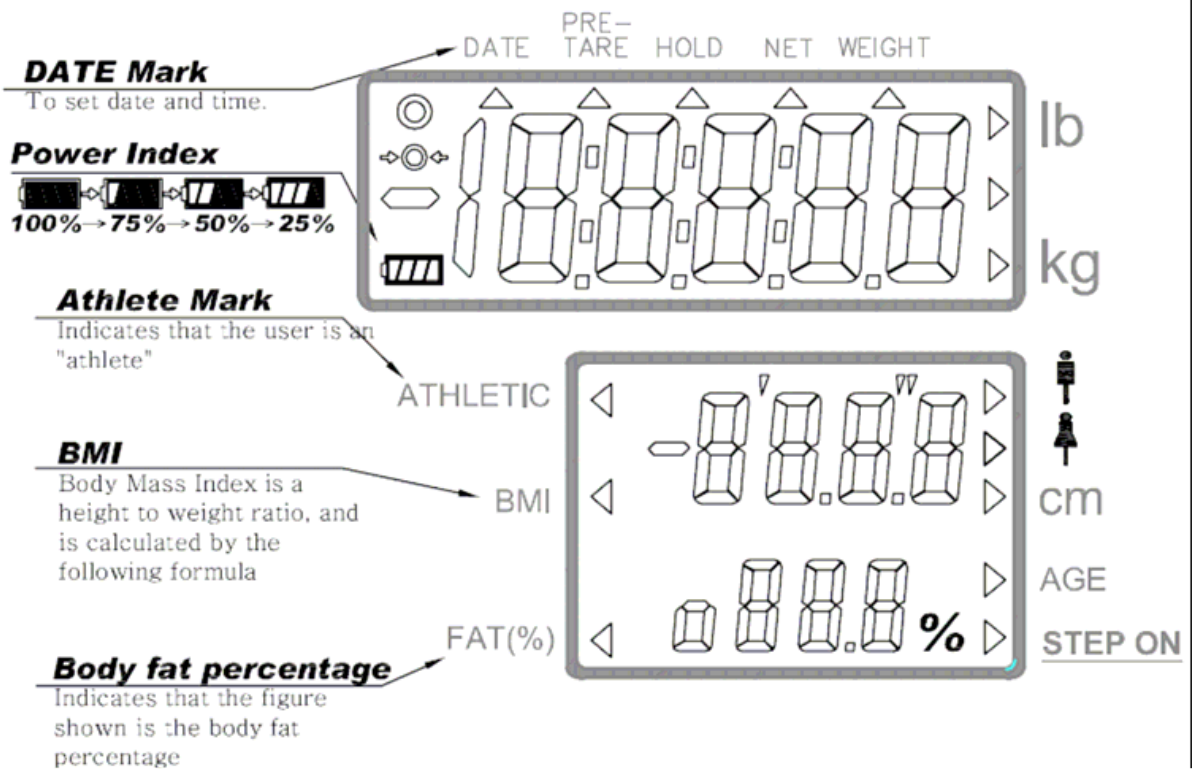

## Before Operation

1. Install rechargeable battery pack in the battery box of indicator or plug the connector of AC ADAPTOR (12V 2A) in the indicator.



2. Assemble the cable to the printer, then connecting its 9D connector to the indicator
3. Make sure the paper is installed in the printer.

## Setting the time and date



1. Press ON/OFF key, switch on the scale.
2. Press TIME key, entering the DATE/TIME SETTING MENU “Year” of last record will be displayed at the top of the LCD; the 1<sup>st</sup> digit will be flash.
3. Change the flash digit by pressing the numerical key on the control panel.
4. Press TIME key, entering DATE menu.
5. Change the flash digits by pressing the numerical key on the control panel.
6. Press TIME key, entering TIME menu.
7. Change the flash digit by pressing the numerical key on the control panel.

Format of display:

- Year: YYYY
- Date: MM.DD
- Time: HR:MIN

8. Press TIME key to save the setting. LCD displays the updated data by sequence of YEAR, DATE and TIME. Return to weighing mode.



# Operation Instructions

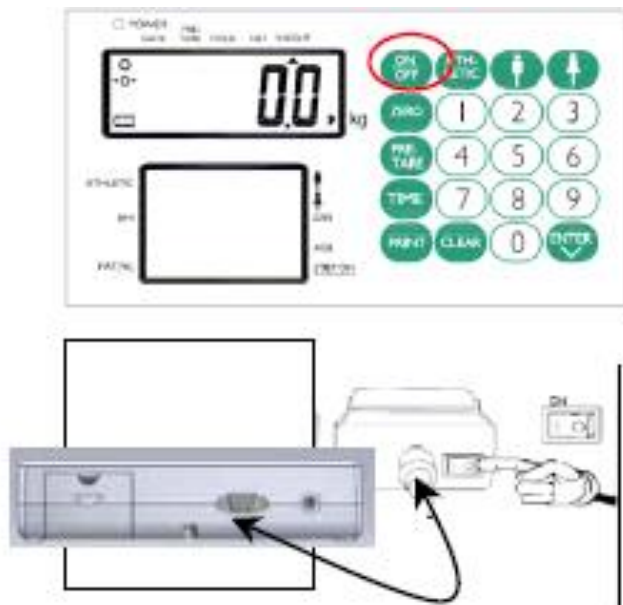

1. Press ON/OFF key. "0.0" will appear on the top LCD.
2. Connecting the TP-2100 printer to the scale by the cable supplied in the packaging of the printer. Turn on the printer by pressing the I/O switch button which is built at the rear of the printer.
3. Press PRE-TARE key. Input the weight of your clothes. A minus weight will be displayed at the top LCD.
4. Select the body type by pressing one of the  buttons.
5. Press ENTER key, entering setting mode of personal data. A height number will be displayed at flash at the 1<sup>st</sup> digits. Input your height by pressing the numerical key of control panel, or automatically transferred from the HM-201D height measurement.
6. Press ENTER key, an age number displayed and flash at the 1<sup>st</sup> digits. Input your age



## Operation Instruction



7. Press ENTER key, a flashing arrow appears next to STEP ON.

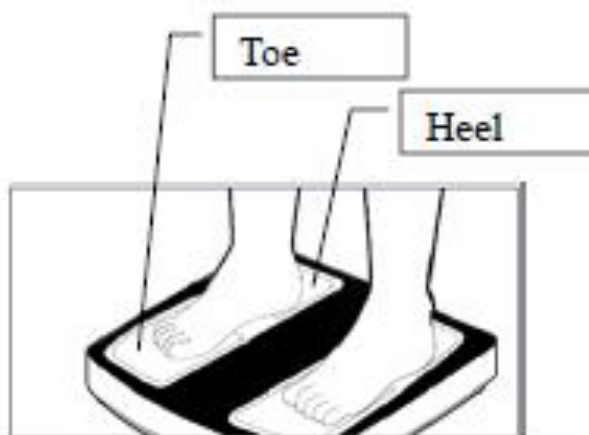

8. Step on the four electrodes of platform with bare feet. Stand in a stable position without bending your knees.



9. Weight will be displayed on the top of the LCD then  will appear and digits running one by one at the bottom for a few seconds.



10. BMI and fat % displayed

11. Press "PRINT" button of printer, the measurements result will be printed out. (refer to page 15 for the sample). Tear it from the printer.

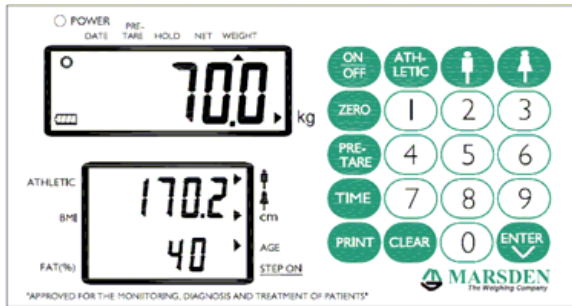

12. Press the ENTER key to switch the monitor of bottom LCD between height, age and BMI, fat %.

13. Press CLEAR key, return to the weighing mode

P.S: The following data will be printed on the paper of the printer:

BMI, FAT %, FAT MASS, FFM, BMR, TBW AND IMPEDANCE

## Set Up Your Device

When the scale is switched on, hold the [ZERO] key pressed for about 3 seconds until the display shows successively the “SETUP” and “A.OFF” symbols.

Selection is carried out with the [TARE] → and [HOLD] ↓ keys.

### Auto-off Time Set-Up

This enables operator to setup period to shut off device with no operation automatically.

When the END is selected, the setting can be finished with the [HOLD] key.

# RS-232 Interface Instructions

## Specification

Communication Standard	EIA RS-232 Compatible
Communication Method	Asynchronous Transmission
Signal Speed	9600
Data Length	8 bits
Parity Check	None
Stop Bit	1 bit
Handshake	None
Data Code	ASCII

## Signal Lines and Connection Methods

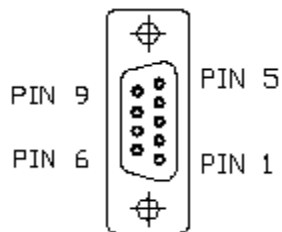

Terminal Number	Signal Name
2	TX
3	RX
5	GND

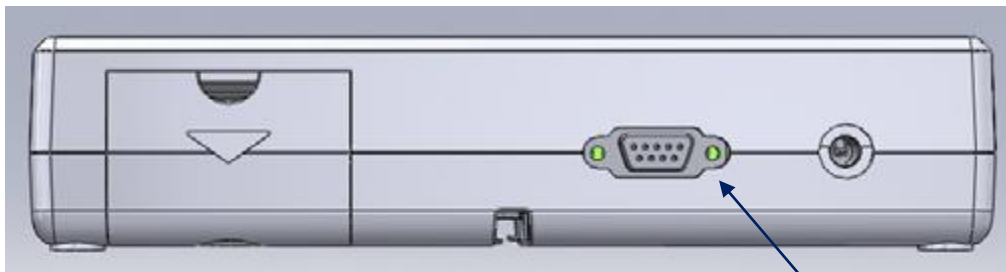

RS-232 Connector

Use an RS-232 cross cable when connecting to a personal computer or printer TP-2100

## Format of the print out

MBF-6000	
31/03/2009	14:55
BODY TYPE	STANDARD
GENDER	MALE
AGE	40
HEIGHT	170.2 cm
PRE-TARE	0.0 kg
NET WEIGHT	70.0 kg
BMI	24.7
FAT%	21.0 %
FAT MASS	14.7 kg
FFM	55.3 kg
BMR	1660 kcal
TBW	40.6 kg
IMPEDANCE	402.2ohm

## Assembly Instructions

To install the HM-201D with the MBF-6000

The connection point between the MBF-6000 indicator and HM-201D is illustrated below:

Digital Height Measure data cable socket on MBF-6000 Indicator

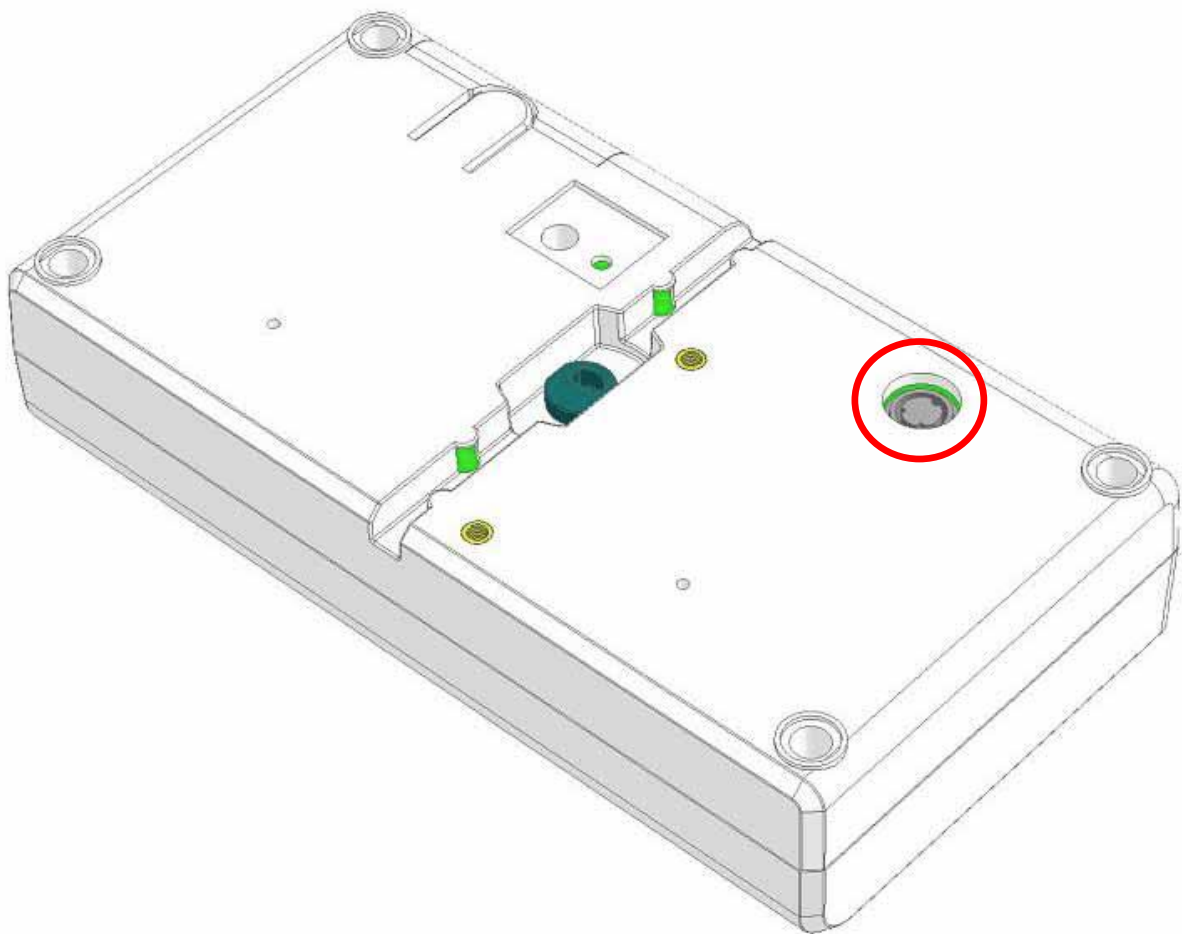

Insert the HM-201D data cable into the socket of the MBF-6000 Indicator before use.

## Body impedance measurement methods

In the conventional 4-electrode method, current is supplied from the electrodes at the tips of the toes on both feet, with the voltage measured on the heel. This current flows from one lower limb through the lower abdomen and then into the other lower limb, and the bio electrical impedance (hereinafter, impedance,) thus measured is the impedance between the two feet. For reference, the impedance measurement methods for the legs are shown in the diagram below.

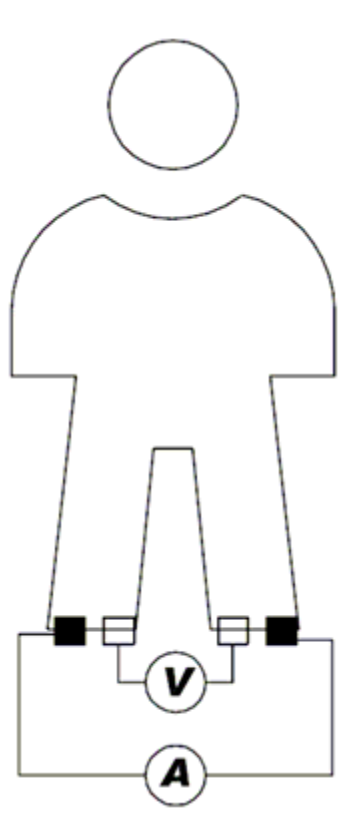

## Instruction for replacing batteries

1. Open the battery housing cover, and take out the battery housing. Reset the rechargeable battery. Make sure the rechargeable battery is properly placed.

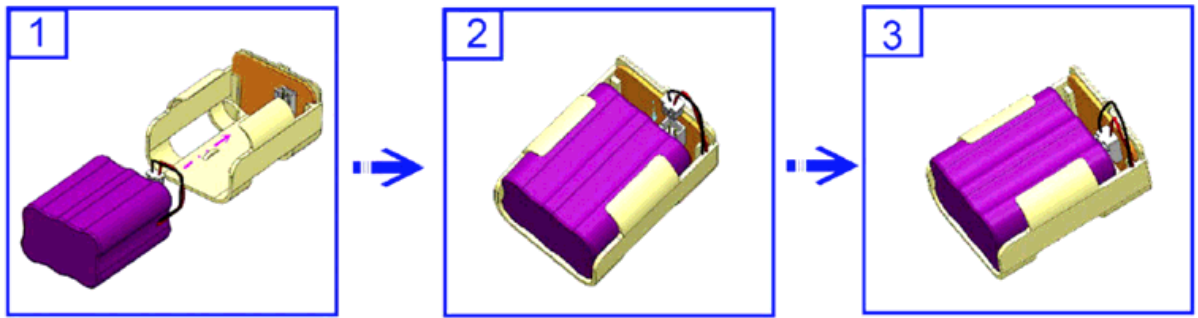

2. Place the battery housing back and make sure that the housing pin is connecting to the right point.

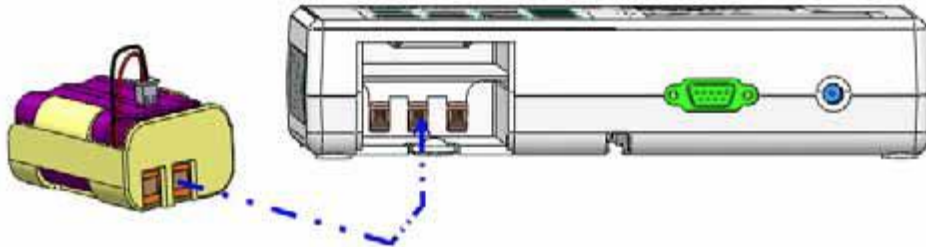

3. Place the housing back, and close the battery housing cover.





# MBF-6010 Assembly





1. Put the column on the base

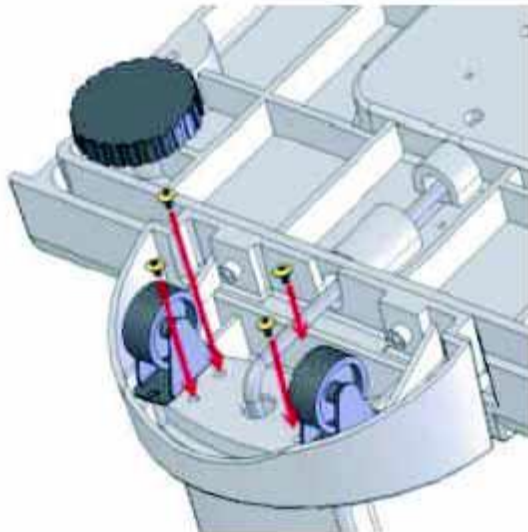

2. Screw up the column and base.

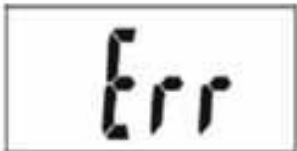

## Error Messages

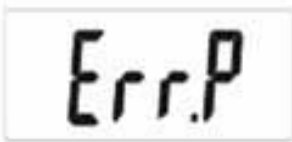
ERROR MESSAGE	REASON	ACTION
	Low Battery: This warning shows that the voltage of battery is too low to use.	Please replace a new battery or plug the AC adaptor for operation.
	Overload: The total load exceeds the maximum capacity of scale.	Please reduce the loading and try again.
	Counting error(too high): Indicates that the signal from the loadcell is too high.	This error is normally caused by a serious fault on the scales such as a faulty loadcell or wiring. Please contact the local service representatives.
	Counting error(too low): Indicates that the signal from the loadcell is too low.	This error is normally caused by a serious fault on the scales such as a faulty loadcell or wiring. Please contact the local service representatives.
	Zero count over calibration zero range +10% while power on.	Please re-calibrate the instrument.
	Zero count under calibration zero range -10% while power on.	Please re-calibrate the instrument.
	EEPROM Error: Indicates that there is a fault with the scales software.	This error is normally caused by a serious fault on the scales such as a faulty loadcell or wiring. Please contact the loadcell service representatives.



# MARSDEN

ACCURACY ASSURED

<b>Head Office:</b>	
<b>Sales, Service, Marketing &amp; Accounts</b>	Unit 1 Genesis Business Park Sheffield Road Rotherham S60 1DX
<b>Telephone:</b>	0845 13 0 7330
<b>Fax:</b>	0845 13 0 7440
<b>Despatch, Production &amp; Technical Support</b>	
	Unit 7 Centurion Business Park Coggin Mill Way Rotherham S60 1FB
<b>Telephone:</b>	017093 64296
<b>Fax:</b>	017093 64293



































